

**KLEIN®**

Puertas correderas de vidrio con marco  
Glass sliding doors with frame  
Portes coulissantes en verre avec cadre

# FRAME

Interiorismo Vidrio  
Interior Design Glass  
Décoration d'Intérieur Verre

## ES

La familia **FRAME** ofrece una solución versátil y elegante para espacios modernos. Ideal tanto para puertas únicas como para particiones de vidrio, este sistema permite una variedad de configuraciones para adaptarse a cualquier necesidad de diseño y funcionalidad.

### Características Destacadas:

- Diseño estilizado con perfiles verticales más delgados que los horizontales, proporcionando una estética elegante.
- Acabado en aluminio anodizado Matte Black que agrega un toque de modernidad y sofisticación.
- Elemento tapa embellecedora que oculta la tornillería, garantizando un acabado impecable y elegante.
- Incluye perfilería para vidrios fijos en particiones, manteniendo una coherencia estética en todo el conjunto.
- Opción de puerta única con perfilería Lite, ofreciendo flexibilidad de instalación y diversas opciones de perfil para adaptarse a diferentes requerimientos.
- Facilidad de montaje gracias a su sistema industrializado y cortes sencillos, ideal incluso para aquellos sin experiencia previa en instalaciones de metal.
- Capacidad de regulación en altura para adaptarse a desniveles del suelo o irregularidades en las paredes.
- Diseño minimalista que asegura un montaje elegante y sin complicaciones.
- Apto para puertas correderas o particiones de vidrio de 10 mm de espesor, con capacidad de hasta 80 kg de peso.
- Sistema testado con más de 100,000 ciclos según la norma EN1527 y respaldado por una garantía de 5 años.



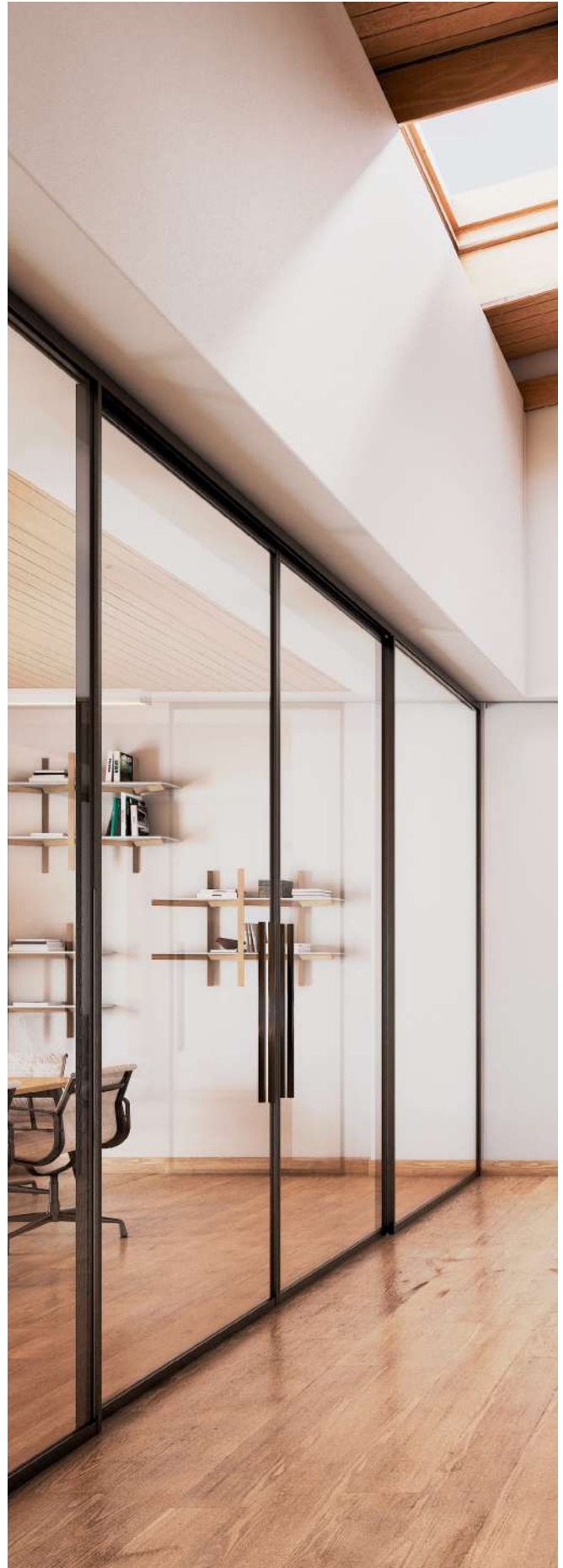

Este sistema de puertas correderas combina funcionalidad, diseño y durabilidad, siendo la opción perfecta para proyectos residenciales o comerciales que buscan un acabado elegante y de calidad.



## ESPECIFICACIONES TÉCNICAS





TECHNICAL SPECIFICATIONS | CARACTERISTIQUES TECHNIQUES

**Puerta única** — **LITE CON MARCO** —  
Single door | Porte unique

-  ..... Peso máximo puerta 80 kg  
..... Maximum door weight 132 lbs
-  ..... Espesor vidrio 10 mm  
..... Glass Thickness 3/8"
-  ..... Ancho puerta 0,75 m - 1,5 m  
..... Door width 30" - 59"
-  ..... Altura puerta max 3 m  
..... Maximum Door Height 118"

Relación Ancho : Alto      **max 1 : 3**  
Width : Height Ratio      **max 1 : 3**

**Partición** — **FRONT CON MARCO** —  
Partition | Partition

-  ..... Peso máximo puerta 80 kg  
..... Maximum door weight 132 lbs
-  ..... Espesor vidrio 10 mm  
..... Glass Thickness 3/8"
-  ..... Ancho puerta 0,75 m - 1,5 m  
..... Door width 30" - 59"
-  ..... Altura puerta max 3 m  
..... Maximum Door Height 118"

Relación Ancho : Alto      **max 1 : 3**  
Width : Height Ratio      **max 1 : 3**



# DOCUMENTACIÓN TÉCNICA

TECHNICAL DOCUMENTATION | DOCUMENTATION TECHNIQUE

## FRAME - LITE CON MARCO

Secciones | Sections | Sections

Cuatro formas de fijar nuestros perfiles con FRAME - LITE CON MARCO | Four ways to fix our profiles with FRAME SIMPLE | Trois façons de définir nos profils avec FRAME SIMPLE

**1** Perfil Visto | Exposed Track | Rail visible

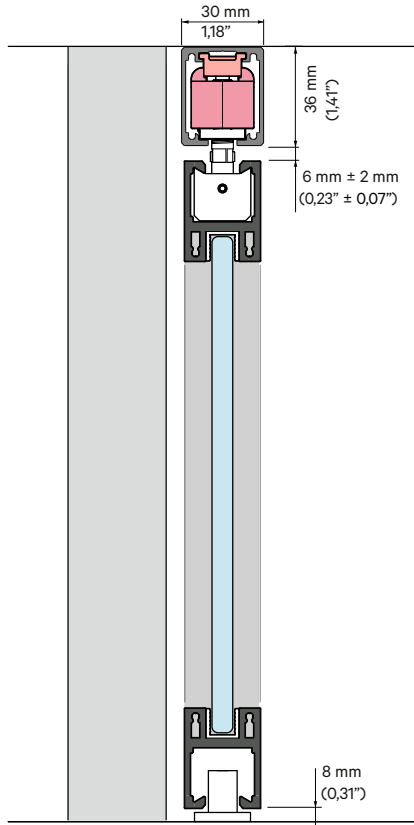

**2** Perfil empotrado "TOP" | Exposed Track | Rail visible

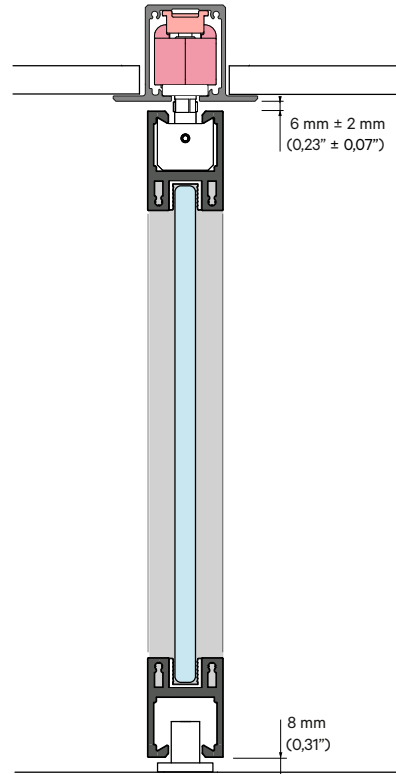

**3** Perfil oculto "T" | Exposed Track | Rail visible

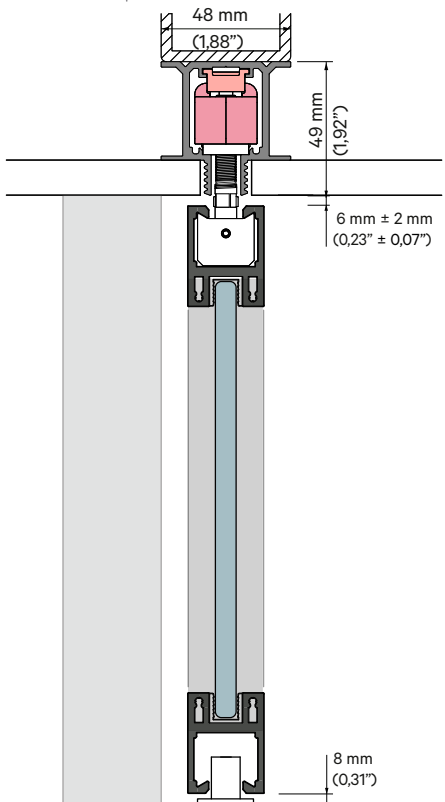

**4** Perfil soporte pared 6 mm / 17 mm | Wall support profile 6 mm / 17 mm | Profil de support mural 6 mm

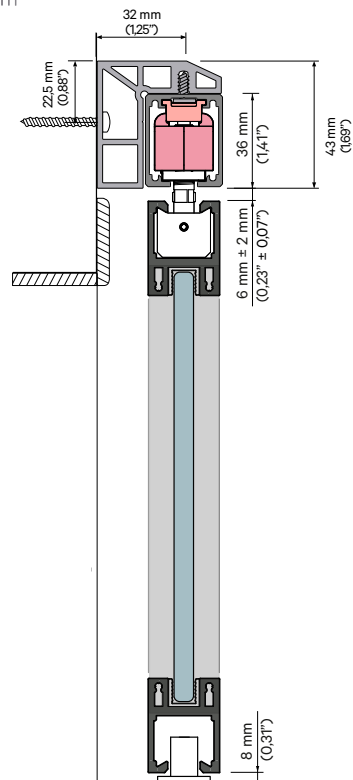

# DOCUMENTACIÓN TÉCNICA

TECHNICAL DOCUMENTATION | DOCUMENTATION TECHNIQUE

••• Plantas | Plan | Plante

- 1 Puerta contra pared con perfil receptor | Door against wall with receiver track | Porte contre le mur avec profil récepteur

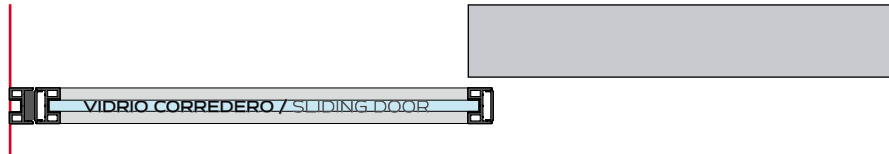

- 2 Puerta contra pared | Door against wall | Porte contre le mur

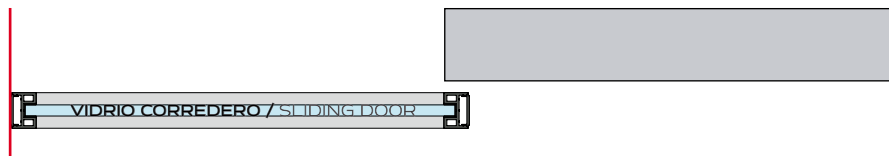

- 3 Puerta centrada | Centered door | Porte centrée



- 4 Puertas enfrentadas | Bi-parting doors | Portes opposées



- i Detalle puerta abierta | Centered door | Porte centrée

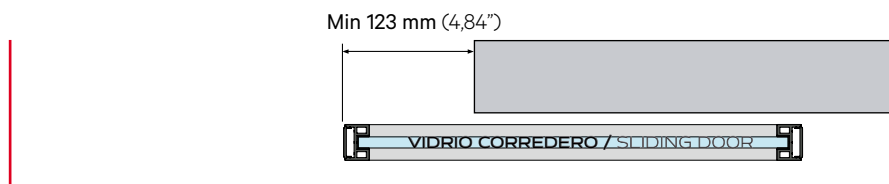

## FRAME - FRONT CON MARCO

Dos formas de fijar nuestros perfiles con FRAME - FRONT CON MARCO | Two ways to fix our profiles with FRAME - FRONT WITH FRAME | Deux façons de fixer nos profils avec FRAME - FRONT AVEC CADRE

**1** Perfil Visto | Exposed Track | Rail visible

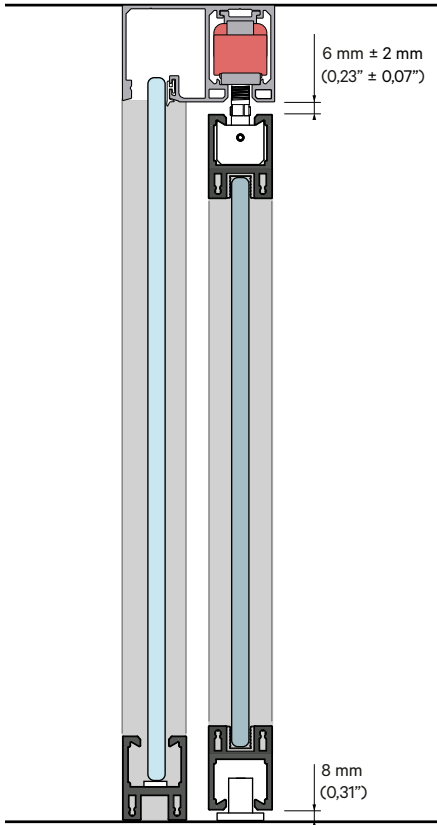

**2** Perfil empotrado "TOP" | Recessed profile "TOP" | Profil encastré "TOP"

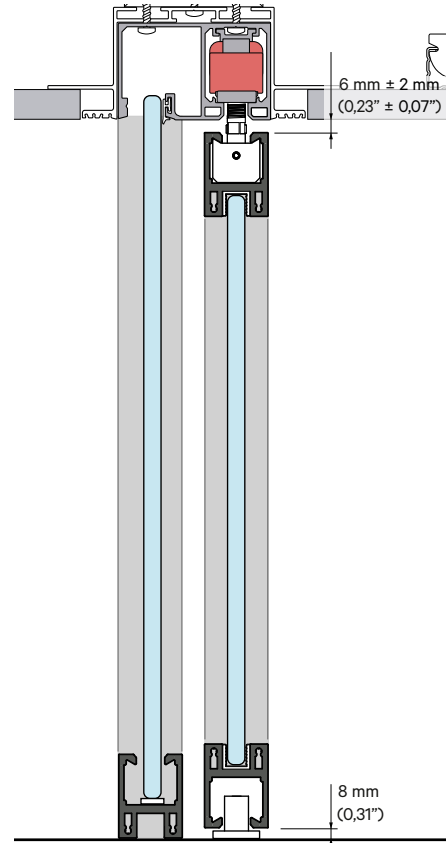

# DOCUMENTACIÓN TÉCNICA

TECHNICAL DOCUMENTATION | DOCUMENTATION TECHNIQUE

••• Plantas | Plan | Plante

- 1** Puerta + Vidrio fijo con perfil receptor | Door + Fixed glass with receiving profile | Porte + Vitre fixe avec profil récepteur

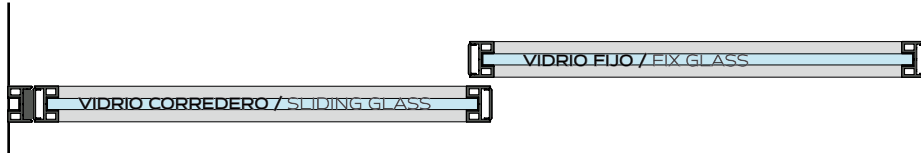

- 2** Puerta + Vidrio fijo | Door + Fixed glass | Porte + vitre fixe

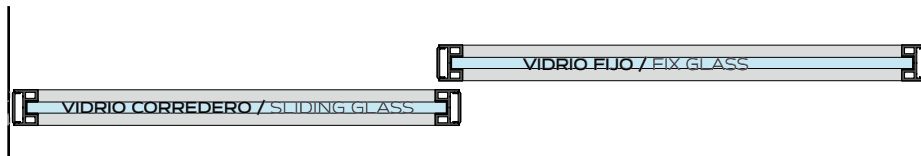

- 3** Vidrio fijo + Puerta + Vidrio fijo | Fixed glass + Door + Fixed glass | Vitre fixe + Porte + Vitre fixe



- 4** Puertas enfrentadas | Bi-parting doors | Portes opposées



- i** Detalle puerta abierta | Centered door | Porte centrée

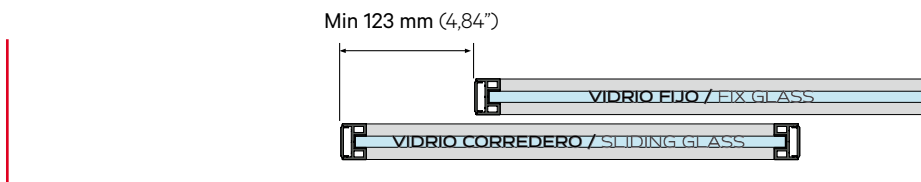





## REFERENCIAS

REFERENCES | RÉFÉRENCES

FRAME - LITE CON MARCO | FRAME - LITE WITH FRAMED DOOR | FRAME - LITE AVEC PORTE ENCADRÉE

**ES**

FRAME - LITE CON MARCO			
Referencia	Descripción	Unidad	Imagen
4342	KIT FRAME - LITE CON MARCO (PUERTA 1m) 2m	1	A
4343	KIT FRAME - LITE CON MARCO (PUERTA 1,5m) 3m	1	A
4352	KIT FRAME - LITE TOP CON MARCO (PUERTA 1m) 2m	1	B
4353	KIT FRAME - LITE TOP CON MARCO (PUERTA 1,5m) 3m	1	B
4362	KIT FRAME - LITE "T" CON MARCO (PUERTA 1m) 2m	1	C
4363	KIT FRAME - LITE "T" CON MARCO (PUERTA 1,5m) 3m	1	C

**ENG**

FRAME - LITE WITH FRAMED DOOR			
Reference	Description	Units	Image
4342	KIT FRAME - LITE W/FRAMED DOOR (1m DOOR) 2m (78")	1	A
4343	KIT FRAME - LITE W/FRAMED DOOR (1,5m DOOR) 3m (118")	1	A
4352	KIT FRAME - LITE TOP W/FRAMED DOOR (1m DOOR) 2m (78")	1	B
4353	KIT FRAME - LITE TOP W/FRAMED DOOR (1,5m DOOR) 3m (118")	1	B
4362	KIT FRAME - LITE "T" W/FRAMED DOOR (1m DOOR) 2m (78")	1	C
4363	KIT FRAME - LITE "T" W/FRAMED DOOR (1,5m DOOR) 3m (118")	1	C

**FR**

FRAME - LITE WITH FRAMED DOOR			
Référence	Description	Unité	Image
4342	KIT FRAME - LITE AVEC PORTE ENCADRÉE (1m DOOR) 2m	1	A
4343	KIT FRAME - LITE AVEC PORTE ENCADRÉE (1,5m DOOR) 3m	1	A
4352	KIT FRAME - LITE TOP AVEC PORTE ENCADRÉE (1m DOOR) 2m	1	B
4353	KIT FRAME - LITE TOP AVEC PORTE ENCADRÉE (1,5m DOOR) 3m	1	B
4362	KIT FRAME - LITE "T" AVEC PORTE ENCADRÉE (1m DOOR) 2m	1	C
4363	KIT FRAME - LITE "T" AVEC PORTE ENCADRÉE (1,5m DOOR) 3m	1	C

ACCESORIOS COMPATIBLES — COMPATIBLE ACCESSORY — ACCESSOIRES COMPATIBLES

PF. RECEPTOR FRAME			
Ref.	Description	U.	Image
4320	PF. RECEPTOR FRAME 3m   PF. RECEIVER FRAME 3m (118")   PF. RECEPTEUR FRAME 3m	1	F

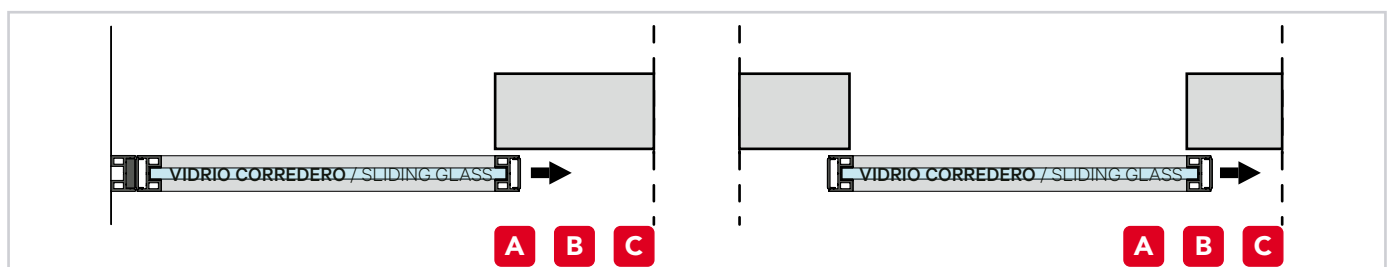

FRAME - FRONT CON MARCO | FRAME - FRONT WITH FRAMED DOOR | FRAME - FRONT AVEC PORTE ENCADRÉE

**ES**

FRAME - FRONT CON MARCO			
Referencia	Descripción	Unidad	Imagen
4372	KIT FRAME - FRONT CON MARCO (PUERTA 1m) 2m	1	D
4373	KIT FRAME - FRONT CON MARCO (PUERTA 1m) 3m	1	D
4374	KIT FRAME - FRONT CON MARCO (PUERTA 1m) 4m	1	D
4383	KIT FRAME - FRONT CON MARCO (PUERTA 1,5m) 3m	1	D
4384	KIT FRAME - FRONT CON MARCO (PUERTA 1,5m) 4m	1	D

**ENG**

FRAME - FRONT WITH FRAMED DOOR			
Reference	Description	Units	Image
4372	KIT FRAME - FRONT W/FRAMED DOOR (1m DOOR) 2m (78")	1	D
4373	KIT FRAME - FRONT W/FRAMED DOOR (1m DOOR) 3m (118")	1	D
4374	KIT FRAME - FRONT W/FRAMED DOOR (1m DOOR) 4m (157")	1	D
4383	KIT FRAME - FRONT W/FRAMED DOOR (1,5m DOOR) 3m (118")	1	D
4384	KIT FRAME - FRONT W/FRAMED DOOR (1,5m DOOR) 4m (157")	1	D

**FR**

FRAME - FRONT WITH FRAMED DOOR			
Référence	Description	Unité	Image
4372	KIT FRAME - FRONT AVEC PORTE ENCADRÉE (1m DOOR) 2m	1	D
4373	KIT FRAME - FRONT AVEC PORTE ENCADRÉE (1m DOOR) 3m	1	D
4374	KIT FRAME - FRONT AVEC PORTE ENCADRÉE (1m DOOR) 4m	1	D
4383	KIT FRAME - FRONT AVEC PORTE ENCADRÉE (1,5m DOOR) 3m	1	D
4384	KIT FRAME - FRONT AVEC PORTE ENCADRÉE (1,5m DOOR) 4m	1	D

ACCESORIOS COMPATIBLES — COMPATIBLE ACCESSORY — ACCESSOIRES COMPATIBLES

PF. RECEPTOR FRAME   PF. RECEIVER FRAME   PF. RECEPTEUR FRAME			
Ref.	Description	U.	Image
4320	PF. RECEPTOR FRAME 3m   PF. RECEIVER FRAME 3m (118")   PF. RECEPTEUR FRAME 3m	1	F

JUEGO PERFILES VERTICALES   SET VERTICAL TRACKS   ENSEMBLE DE PROFILS VERTICAUX			
Ref.	Description	U.	Image
4322	JGO. 2 PFS. VERTICALES FRAME 3m   SET OF 2 VERTICAL TRACKS FRAME 3m (118")   JEU 2 RAILS VERTICAUX FRAME 3m	1	E

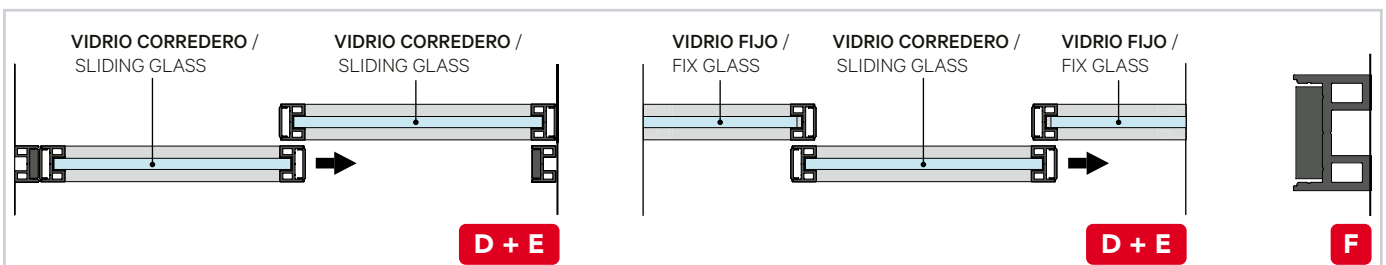

# KLEIN®

KLEIN EUROPE  
Edificio KLEIN  
Polígono Industrial Can Cuyás  
N-150 Km. 1  
08110 Montcada i Reixac  
Barcelona (Spain)

Tel: +34 935 760 101  
Fax: +34 935 760 109  
  
+Info  
klein@klein.es  
www.klein.pro

Síguenos en redes  
Follow us on social media



KLEIN USA, Inc.®  
1 Madison Street  
East Rutherford, NJ 07073

Phone: 973 246 8181  
Fax: 973 246 8362  
  
+Info  
info@klein-usa.com  
www.klein.pro

Follow us on social media  
Síguenos en redes

